



EVOLUTION OF WROUGHT IRON

CONTEMPO

**Italian Heritage.
Trending Design.**



**Versatile Balusters.
Patterned Panels.**



**Forged Steel.
Unparalleled
Craftsmanship.**

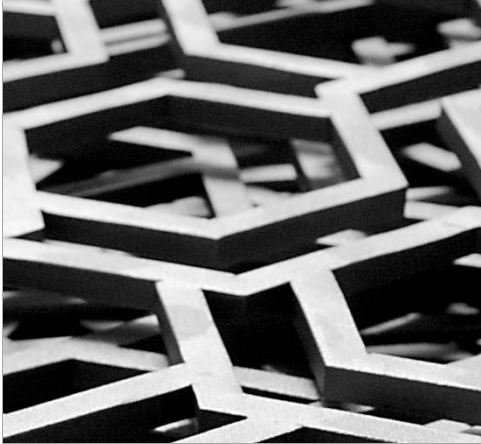

**Contemporary
& Modern:
CONTEMPO**

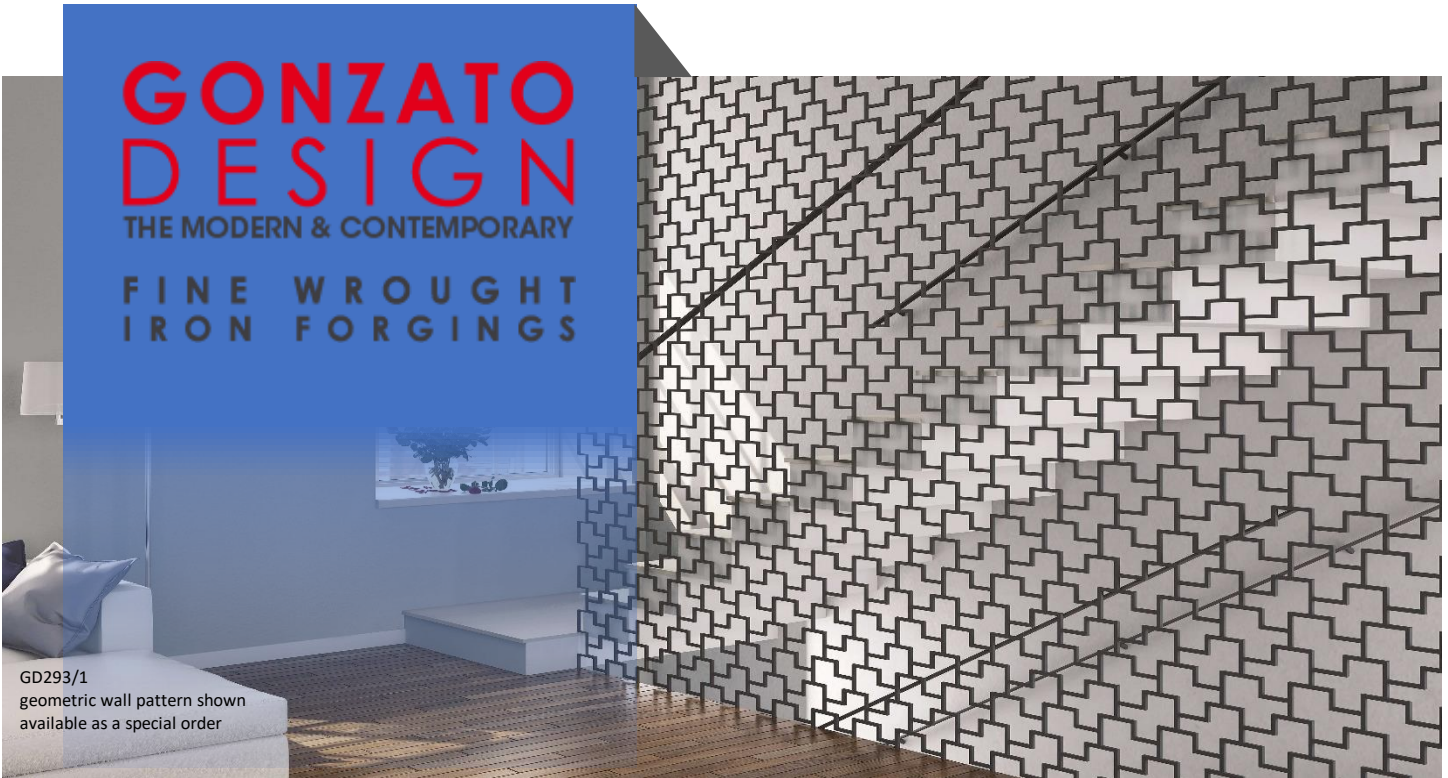

Classical wrought iron motifs have evolved into of-the-moment inspirations, blending contemporary influences with modern geometric patterns to form the **Gonzato Design Collection**.

This **Feature Insert** highlights **NEW PRODUCTS**, along with those that have proven to have lasting appeal. From eye catching stair balusters to mesmerizing geometric railing and wall patterns, open your vision to the numerous possibilities. As you browse throughout this unique selection of handcrafted items, keep in mind that our Design Team can assist you with 3D imagery services, allowing you to visualize your project prior to ordering. Likewise, our Customer Service team is readily available to confirm cost and shipping, along with recommendations of compatible hand railing, newel posts, and accents.

From palaces to museums, universities to custom homes, Indital has a rich history of enhancing the world's architecture. With our innovative Gonzato Design line, featuring the **Contempo Selection**, the strength and boldness of handcrafted wrought iron delivers endless potential for your residential and commercial designs. **Creativity, Precision, and Innovation awaits.**

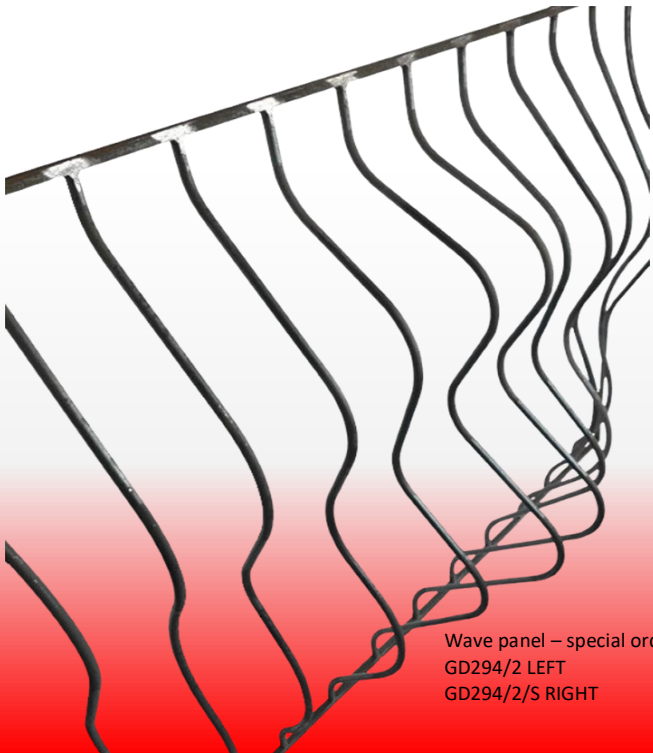

Wave panel – special order
 GD294/2 LEFT
 GD294/2/S RIGHT



CONTEMPO SELECTION

Indital is an international manufacturer. *Arteferro* is an Indital brand of premium wrought iron products. *Gonzato Designs* is a unique collection of products within the Arteferro line that melds contemporary with modern design elements. The **Contempo Selection** is a special handselected grouping of product styles that have been highlighted due to market demand along with popular trends that are influencing the aesthetics of today.



BALUSTERS ■ Pages 3-8

PANELS ■ Pages 9-13

ACCESSORIES ■ Page 14

DESIGN SERVICES ■ Page 15

Wrought Iron Balusters



Product	Center Knot Bushing
P/N	F0074/1000
Mtl	9/16"
W	2.5"
H	39 3/8"
Wt	4 lbs
MSRP	\$35.08



F0074/1000



Product	Center Double Curl
P/N	1167/2
Mtl	1/2"
W	3"
H	39 3/8"
Wt	2.3 lbs
MSRP	\$7.58

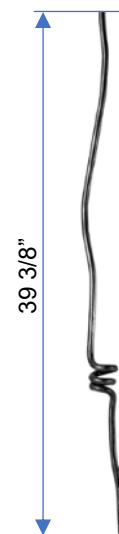

Product	Lower Double Curl
P/N	1167/3
Mtl	1/2"
W	3"
H	39 3/8"
Wt	2.4 lbs
MSRP	\$7.76

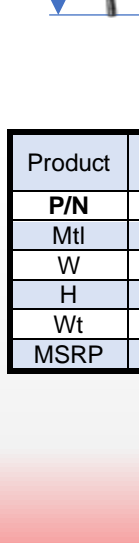

Product	Double 2 & 1 Curl
P/N	1167/1
Mtl	1/2"
W	3"
H	39 3/8"
Wt	2.5 lbs
MSRP	\$9.67

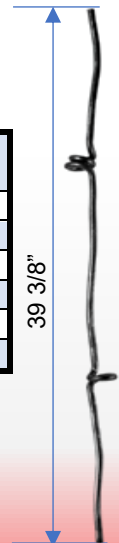

Product	Double 2 & 2 Curl
P/N	1167/4
Mtl	1/2"
W	3"
H	39 3/8"
Wt	2.7 lbs
MSRP	\$10.18

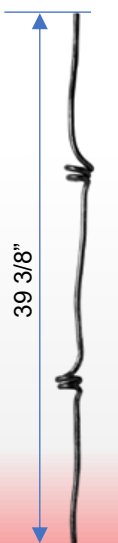

1167/1, 1167/2, 1167/4 & 1167/3



Wrought Iron Balusters



GD29/1 & GD29/2

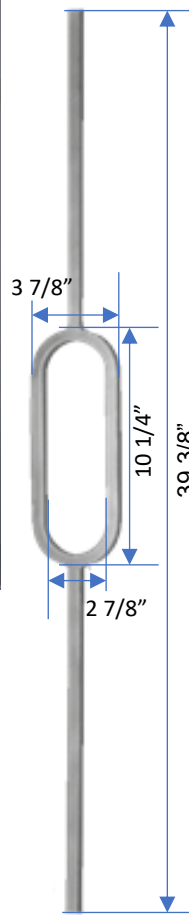

NEW

Product	Single Oval
P/N	GD29/1
Mtl	9/16" <input type="checkbox"/>
W	3 7/8"
H	39 3/8"
Wt	4 lbs
MSRP	\$27.15

NEW

Product	Double Oval
P/N	GD29/2
Mtl	9/16" <input type="checkbox"/>
W	3 7/8"
H	39 3/8"
Wt	5 lbs
MSRP	\$38.29

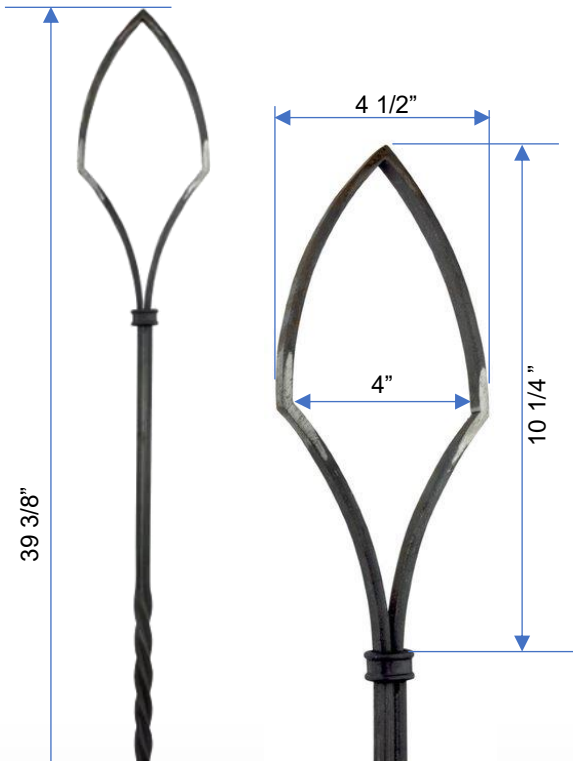
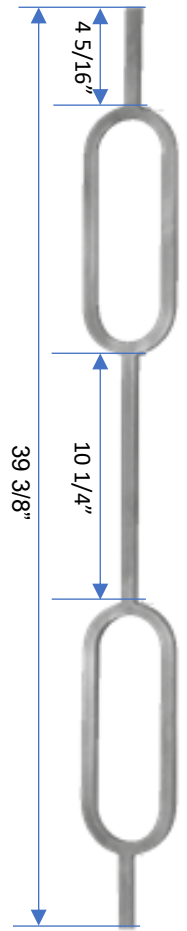

Product	Diamond Head with Grooved Center Twist
P/N	1055/2
Mtl	1/2" x 3/4" <input type="checkbox"/>
W	4 1/2"
H	39 3/8"
Wt	2.4 lbs
MSRP	\$11.62

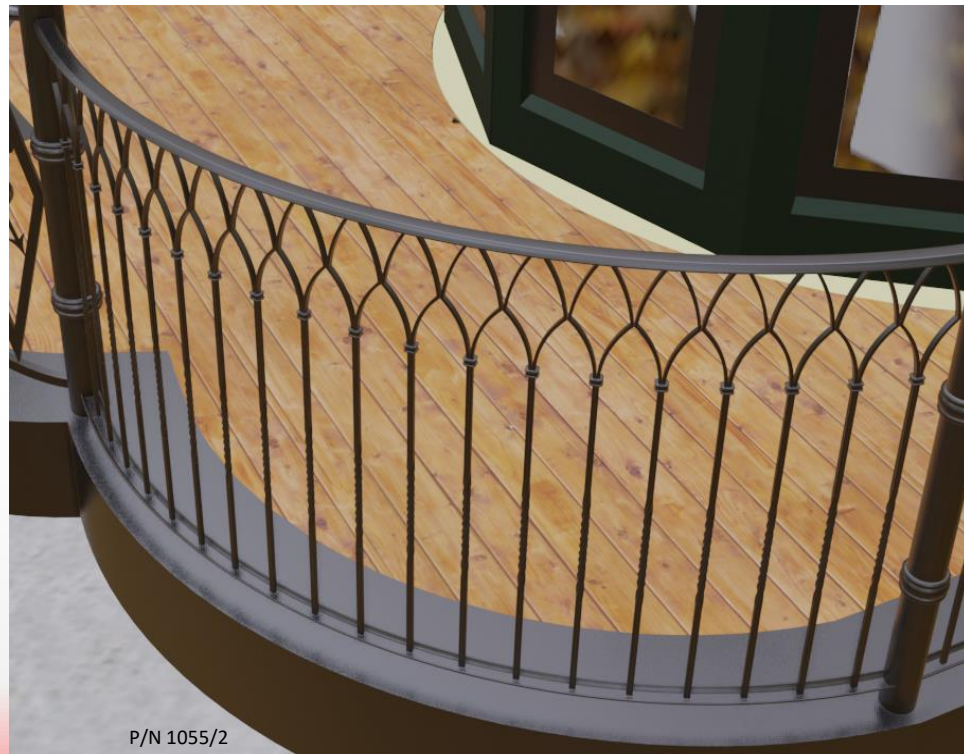

P/N 1055/2



Wrought Iron Balusters

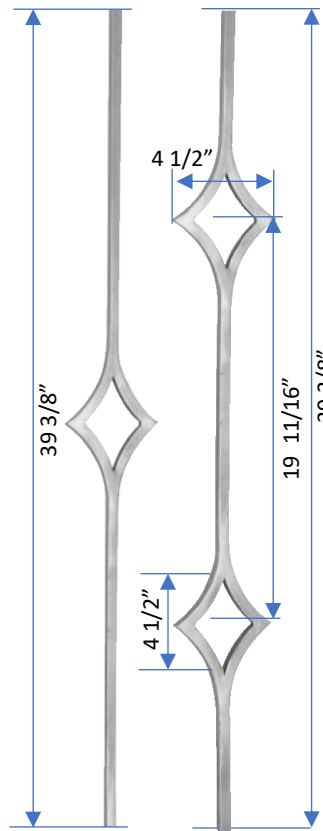

Product	Single Diamond
P/N	GD23/1
Mtl	9/16" <input type="checkbox"/>
W	4 1/2"
H	39 3/8"
Wt	4 lbs
MSRP	\$15.57

Product	Double Diamond
P/N	GD25/1
Mtl	9/16" <input type="checkbox"/>
W	4 1/2"
H	39 3/8"
Wt	4.5 lbs
MSRP	\$26.31

Product	Curved Hexagon
P/N	GD243/2
Mtl	9/16" <input type="checkbox"/>
W	4 3/8"
H	39 3/8"
Wt	3.7 lbs
MSRP	\$23.93

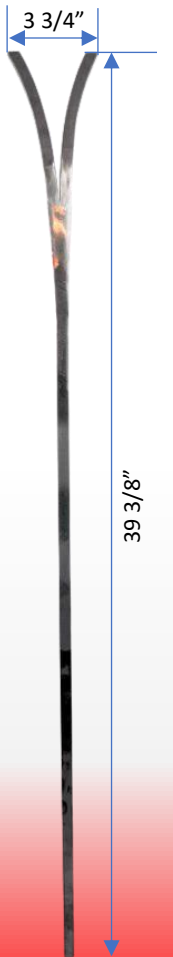
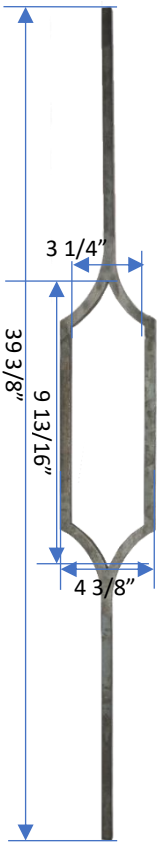

Product	Single Y-Split
P/N	GD290/2
Mtl	1/2" <input type="checkbox"/>
W	3 3/4"
H	39 3/8"
Wt	3.05 lbs
MSRP	\$30.18

Product	Double Y-Split
P/N	GD290/1
Mtl	1/2" <input type="checkbox"/>
W	3 3/4"
H	39 3/8"
Wt	3.75 lbs
MSRP	\$52.95

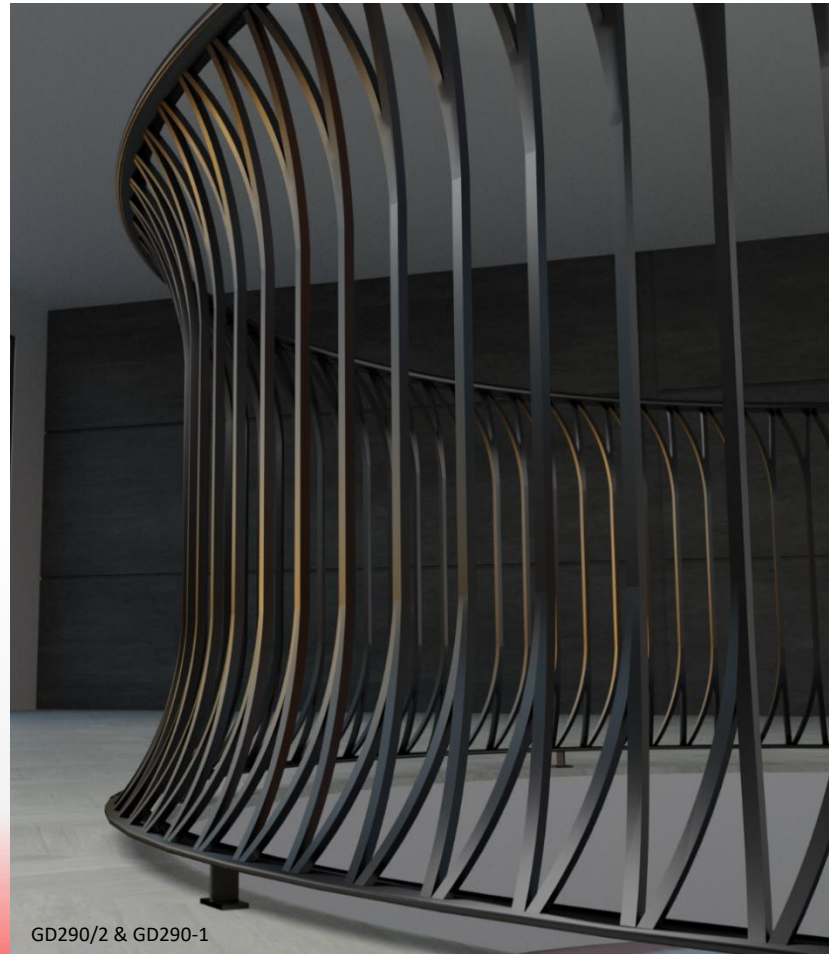
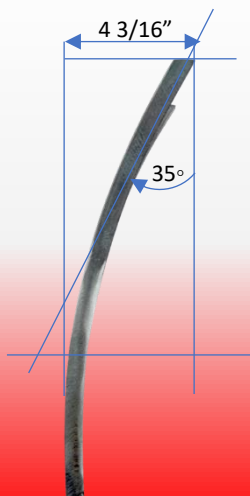
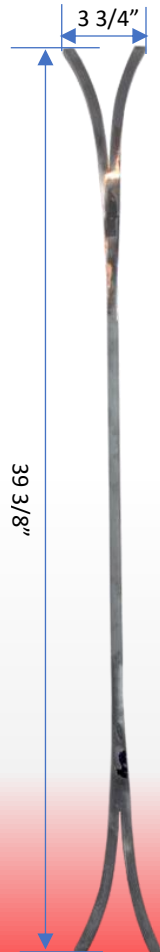

Wrought Iron Balusters

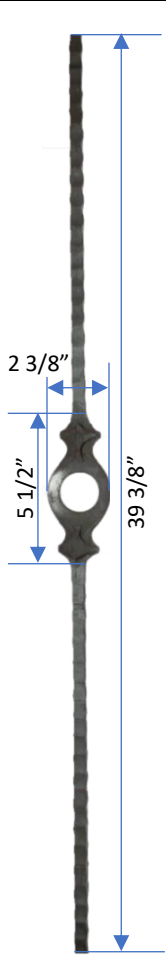

NEW

Product	Single Gothic Ring
P/N	104/5
Mtl	1/2" <input checked="" type="checkbox"/>
W	2 3/8"
H	39 3/8"
Wt	3.2 lbs
MSRP	\$17.75



NEW

Product	Double Gothic Ring
P/N	104/6
Mtl	1/2" <input checked="" type="checkbox"/>
W	2 3/8"
H	39 3/8"
Wt	3.5 lbs
MSRP	\$22.42

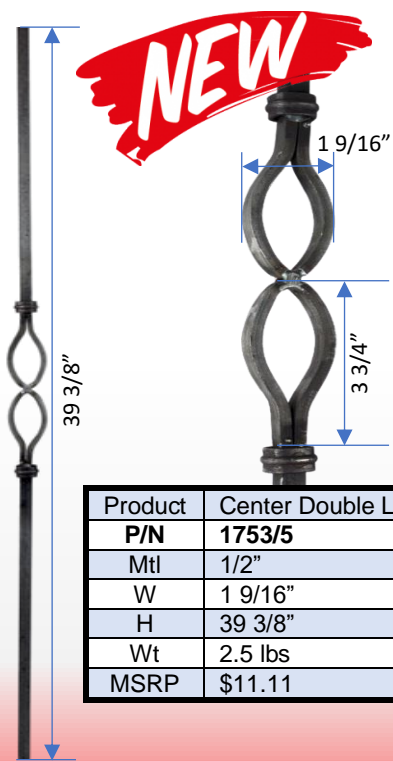
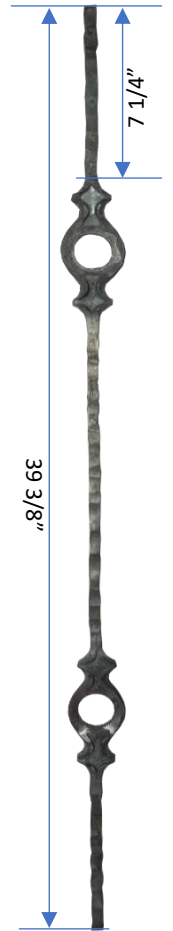

Product	Center Double Loop
P/N	1753/5
Mtl	1/2" <input type="checkbox"/>
W	1 9/16"
H	39 3/8"
Wt	2.5 lbs
MSRP	\$11.11



Product	Center Twist Cane
P/N	1131/3
Mtl	9/16" <input type="checkbox"/>
W	5 1/8"
H	39 1/2"
Wt	3.5 lbs
MSRP	\$7.90

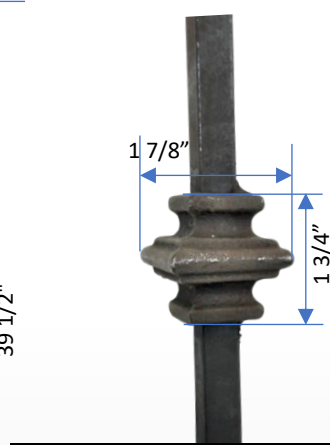
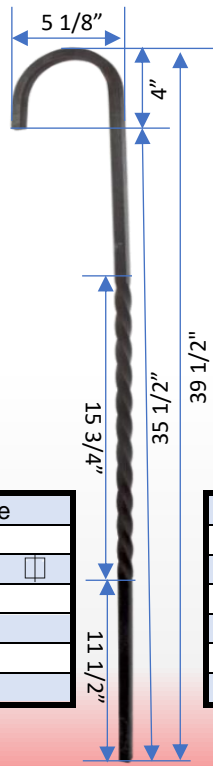

Product	Center Bushing Cane
P/N	1131/1
Mtl	9/16" <input type="checkbox"/>
W	5 3/4"
H	39 1/2"
Wt	4 lbs
MSRP	\$12.40

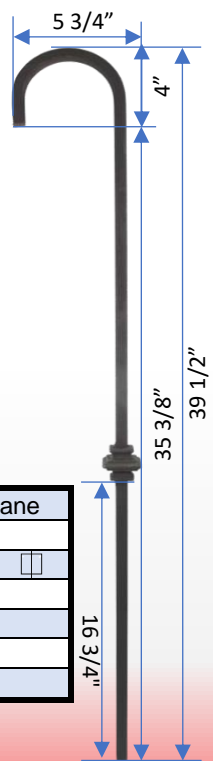

Wrought Iron Balusters

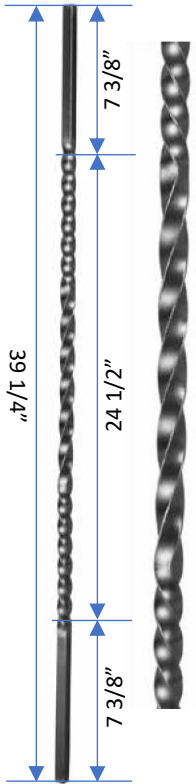

Product	Continuous Three Twist
P/N	GD106/4
Mtl / W	1/2"
H	39 1/4"
Wt	2.5 lbs
MSRP	\$4.69
P/N	GD106/7
Mtl / W	1/2"
H	47 1/4"
Wt	3 lbs
MSRP	\$5.42
P/N	GD106/6
Mtl / W	5/8"
H	39 3/8"
Wt	4.3 lbs
MSRP	\$8.18
P/N	GD106/9
Mtl / W	5/8"
H	47 3/8"
Wt	5.2 lbs
MSRP	\$8.81

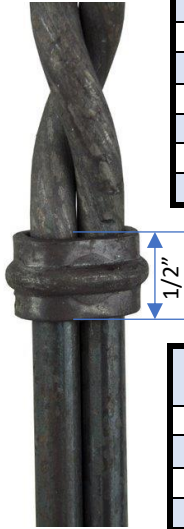

Product	Center Twist Dual Bar
P/N	617/7
Mtl	5/16"
W	5/8"
H	35 7/16"
Wt	1.9 lbs
MSRP	\$5.76

Product	Double Twist Dual Bar
P/N	617/6
Mtl	5/8"
W	5/16"
H	35 7/16"
Wt	1.8 lbs
MSRP	\$7.76

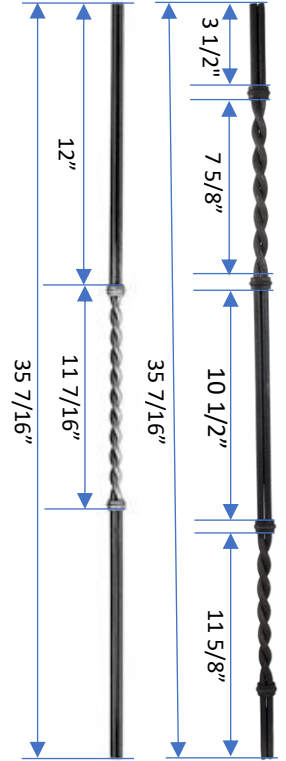

NEW

Product	Single Rectangle
P/N	F0075
Mtl	1/2"
W	3 3/4"
H	44"
Wt	4 lbs
MSRP	\$16.89

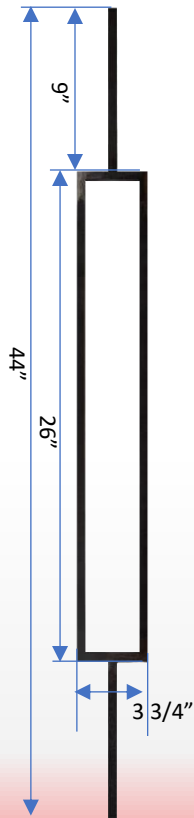

NEW

Product	Double Rectangle
P/N	F0076
Mtl	1/2"
W	3 3/4"
H	44"
Wt	4 lbs
MSRP	\$26.00

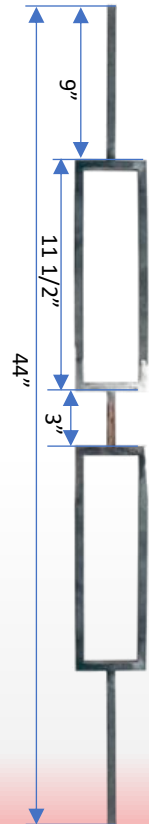

Wrought Iron Balusters

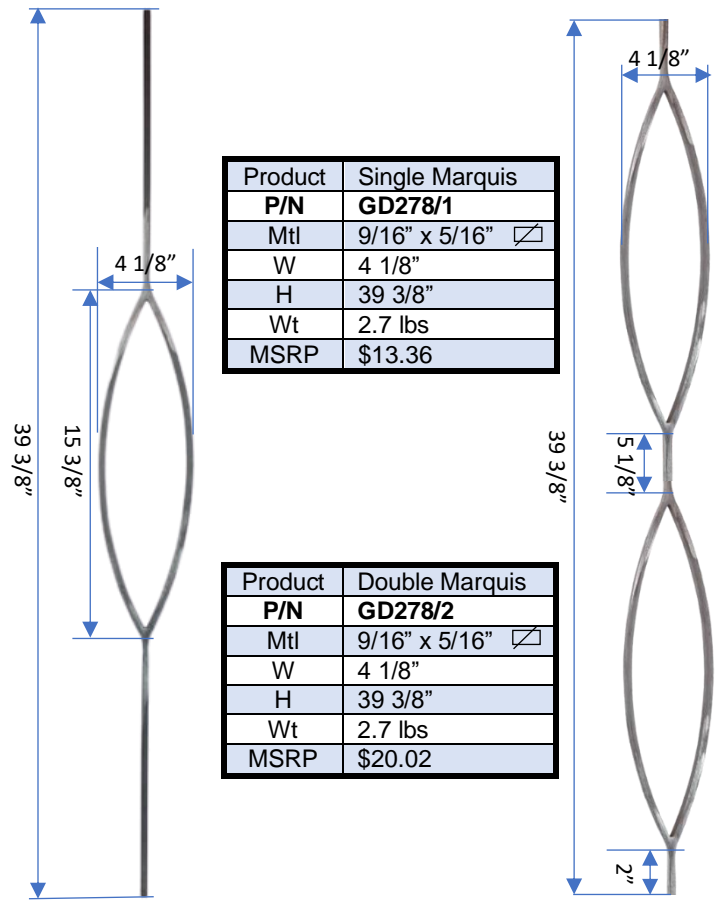

Product	Single Marquis
P/N	GD278/1
Mtl	9/16" x 5/16"
W	4 1/8"
H	39 3/8"
Wt	2.7 lbs
MSRP	\$13.36

Product	Double Marquis
P/N	GD278/2
Mtl	9/16" x 5/16"
W	4 1/8"
H	39 3/8"
Wt	2.7 lbs
MSRP	\$20.02

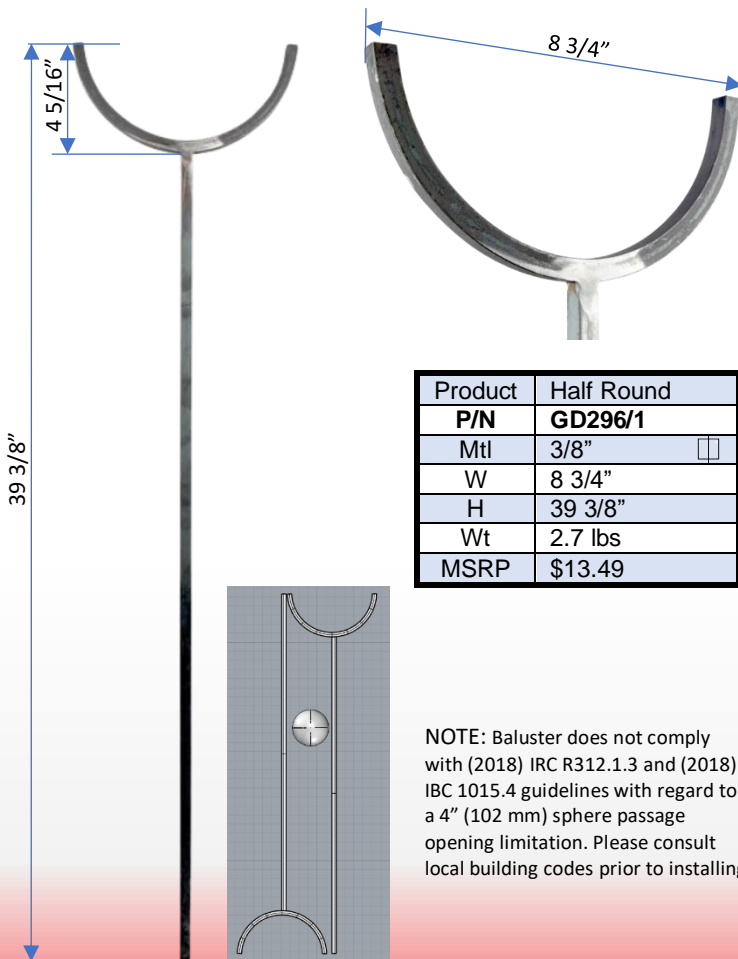

Product	Half Round
P/N	GD296/1
Mtl	3/8"
W	8 3/4"
H	39 3/8"
Wt	2.7 lbs
MSRP	\$13.49

NOTE: Baluster does not comply with (2018) IRC R312.1.3 and (2018) IBC 1015.4 guidelines with regard to a 4" (102 mm) sphere passage opening limitation. Please consult local building codes prior to installing.



Wrought Iron Balusters & Panels



GD301/4 & GD301/5

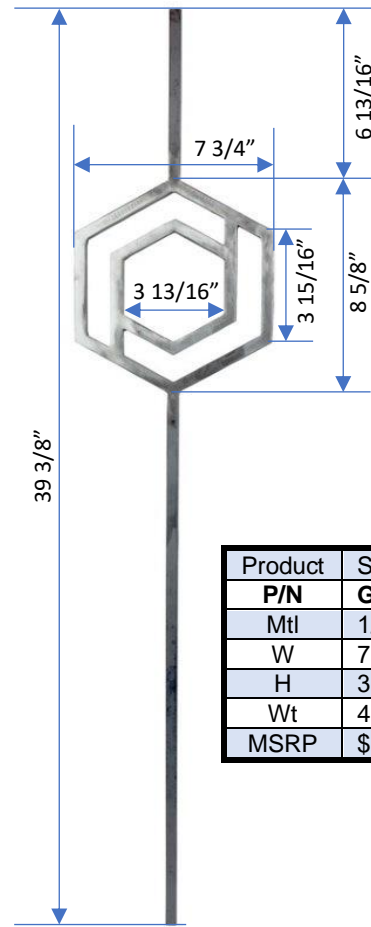

Product	Single Hexagon
P/N	GD301/4
Mtl	1/2" <input type="checkbox"/>
W	7 3/4"
H	39 3/8"
Wt	4.7 lbs
MSRP	\$58.73

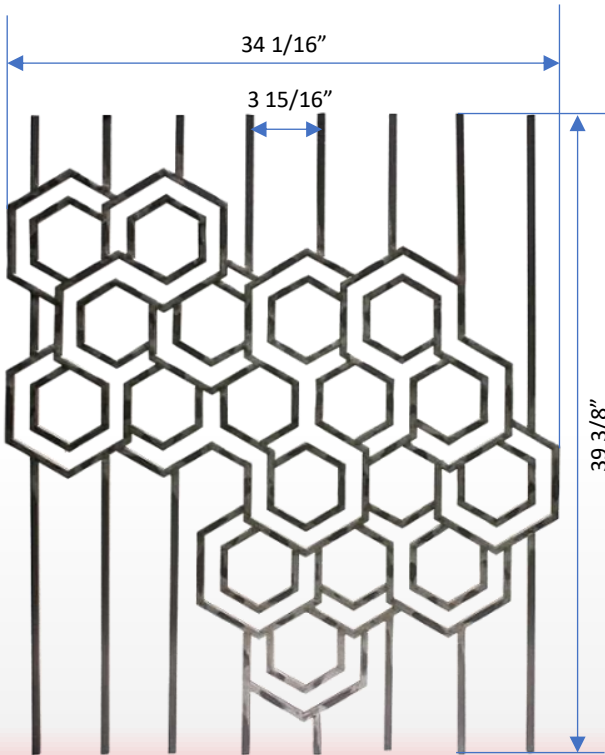

Product	Multi-Hexagon
P/N	GD301/1
Mtl	1/2" <input type="checkbox"/>
W	34 1/16"
H	39 3/8"
Wt	39 lbs
Contact Sales for Pricing	

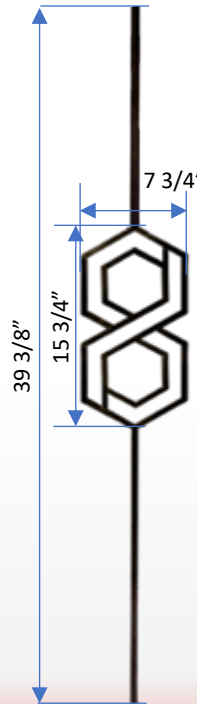

Product	Double Hexagon
P/N	GD301/5
Mtl	1/2" <input type="checkbox"/>
W	7 3/4"
H	39 3/8"
Wt	6.9 lbs
MSRP	\$77.29



Wrought Iron Balusters & Panels

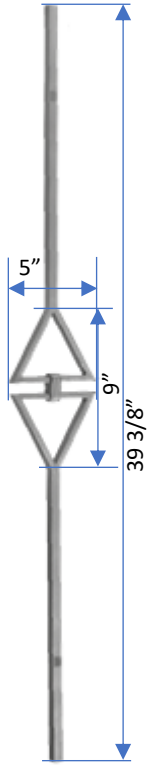

Product	Single Stacked Diamond
P/N	GD181/1
Mtl	9/16" x 5/16"
W	5"
H	39 3/8"
Wt	4.3 lbs
MSRP	\$19.53

Product	Double Stacked Diamond
P/N	GD181/2
Mtl	9/16" x 5/16"
W	5"
H	39 3/8"
Wt	4.8 lbs
MSRP	\$29.87

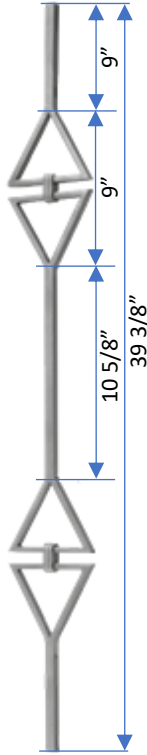

Product	Stacked Diamond Panel
P/N	GD181/3
Mtl	9/16" x 5/16"
W	15 3/4"
H	39 3/8"
Wt	17 lbs
MSRP	\$90.46

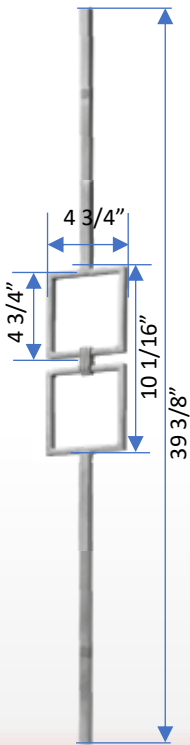
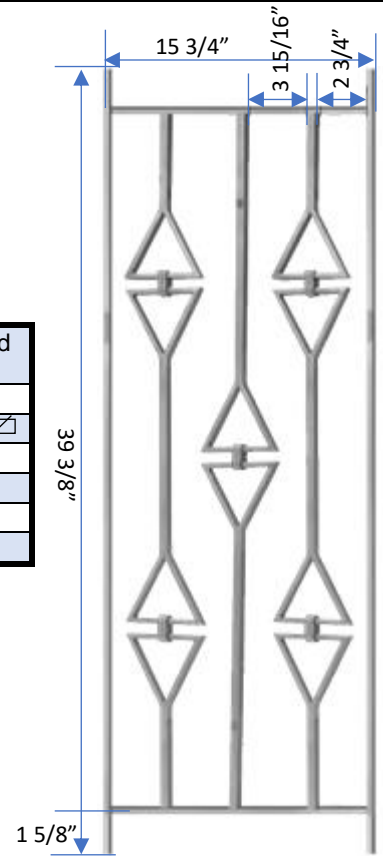

Product	Single Stacked Square
P/N	GD182/1
Mtl	9/16"
W	4 3/4"
H	39 3/8"
Wt	4.4 lbs
MSRP	\$21.18

Product	Double Stacked Square
P/N	GD182/2
Mtl	9/16"
W	4 3/4"
H	39 3/8"
Wt	5.2 lbs
MSRP	\$30.74

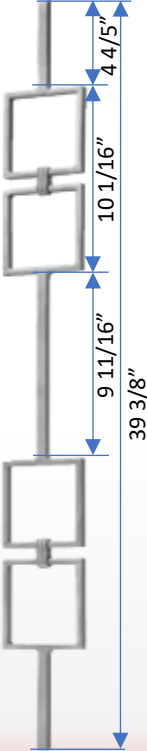

Product	Stacked Square Panel
P/N	GD183/1
Mtl	9/16"
W	15 3/4"
H	39 3/8"
Wt	17.5 lbs
MSRP	\$92.99

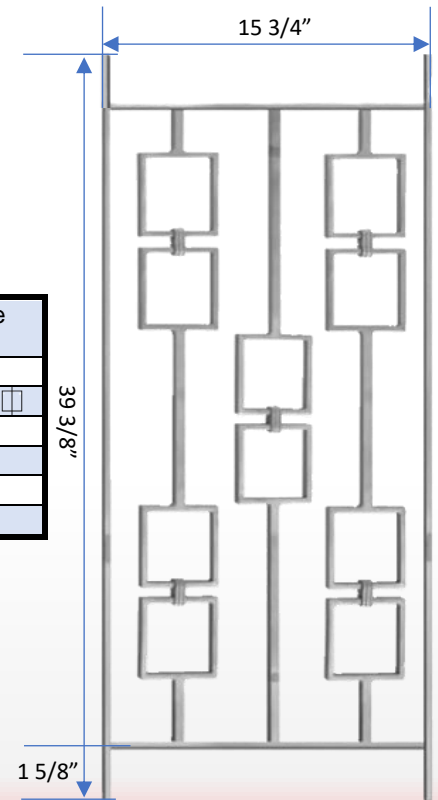

Wrought Iron Balusters & Panels

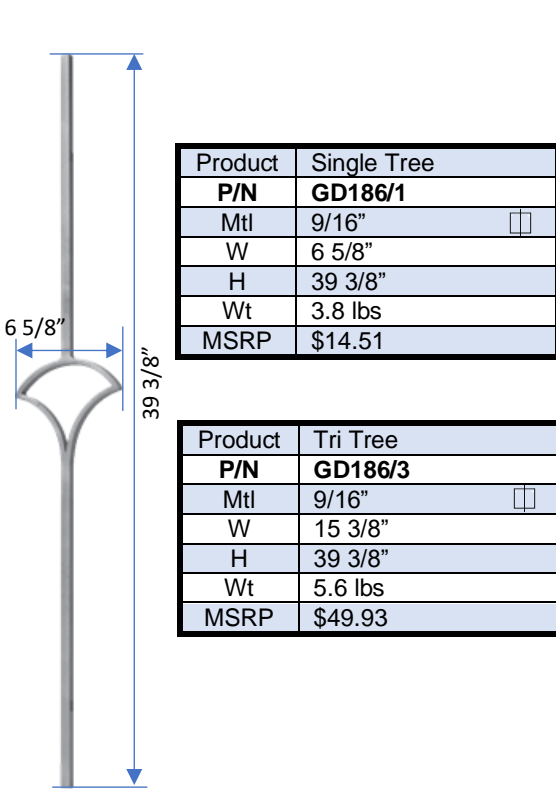

Product	Tri Tree
P/N	GD186/3
Mtl	9/16" <input type="checkbox"/>
W	15 3/8"
H	39 3/8"
Wt	5.6 lbs
MSRP	\$49.93

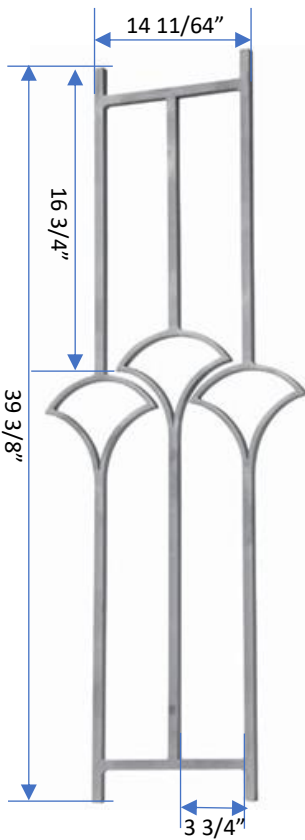

Product	Quad Tree
P/N	GD186/2
Mtl	9/16" <input type="checkbox"/>
W	15 3/8"
H	39 3/8"
Wt	13.4 lbs
MSRP	\$57.77

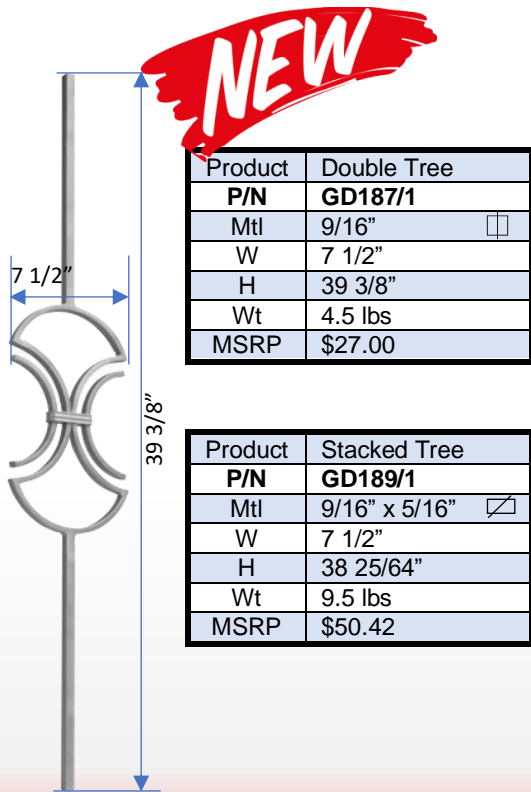
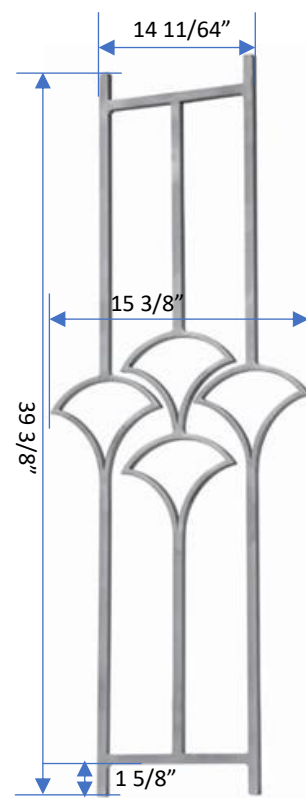

Product	Stacked Tree
P/N	GD189/1
Mtl	9/16" x 5/16" <input checked="" type="checkbox"/>
W	7 1/2"
H	38 25/64"
Wt	9.5 lbs
MSRP	\$50.42

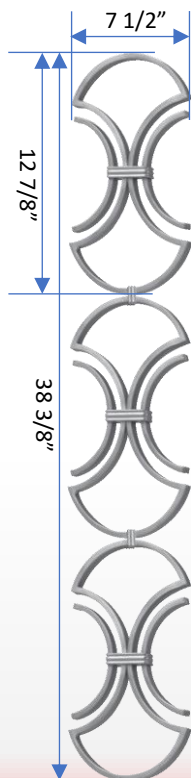

Product	Stacked Double Ring Panel
P/N	GD189/2
Mtl	9/16" x 5/16" <input checked="" type="checkbox"/>
W	13 25/64"
H	39 3/8"
Wt	16.76 lbs
MSRP	\$71.83

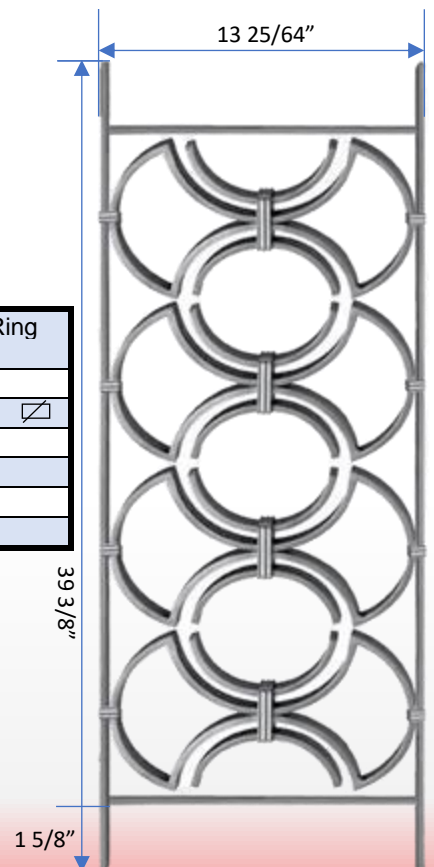

Wrought Iron Panels

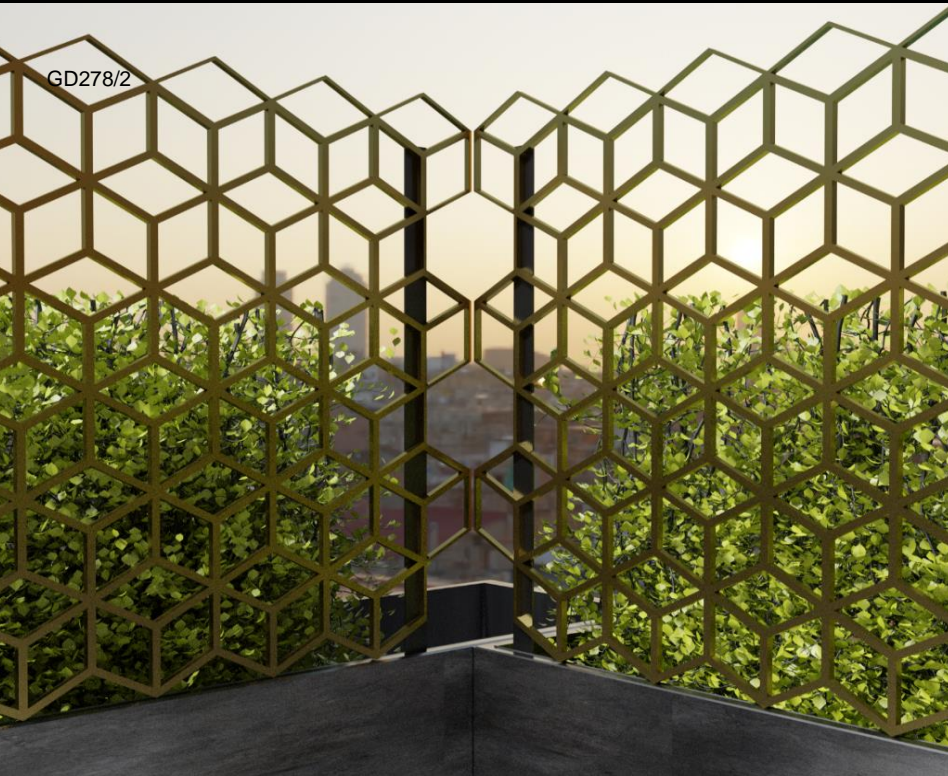

Product	Cube Panel
P/N	GD287/1
Mtl	1/2"
W	28 11/16"
H	39 3/8"
Wt	30 lbs
Contact Sales for Pricing	

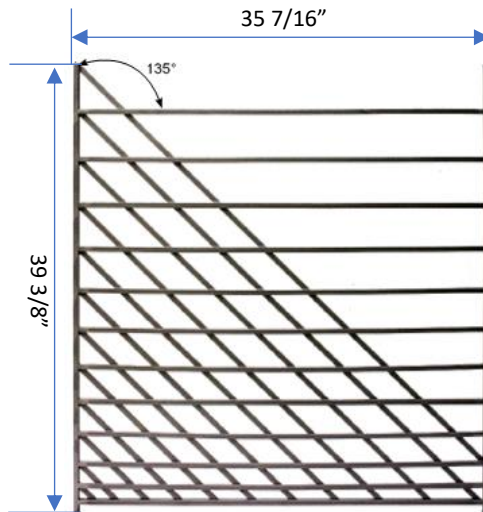
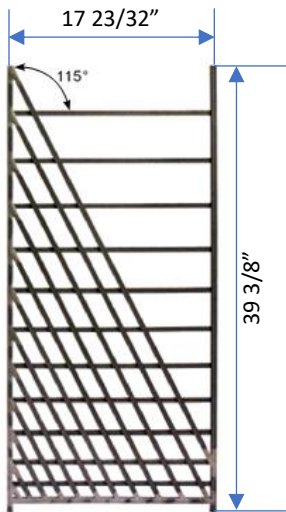
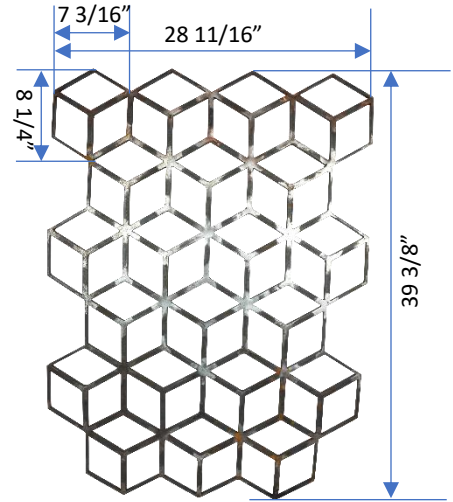

Product	Left Angled Half	Right Angled Half
P/N	GD298/1	GD298/2
Mtl	15/32"	15/32"
W	17 23/32"	17 23/32"
H	39 3/8"	39 3/8"
Wt	18.2 lbs	18.2 lbs
MSRP	\$83.35	\$83.35

Product	Left Angled Panel	Right Angled Panel
P/N	GD297/1	GD297/2
Mtl	15/32"	15/32"
W	35 7/16"	35 7/16"
H	39 3/8"	39 3/8"
Wt	27.6 lbs	27.6 lbs
MSRP	\$99.96	\$99.96



Wrought Iron Panels



Product	Random Ovals
P/N	GD300/2
Mtl	1/2" 
W	29 1/2"
H	39 3/8"
Wt	34.2 lbs
Contact Sales for Pricing	



GD300/2

Product	Wave Panel
P/N	GD294/2
Mtl	1/2" 
W	47 1/4"
H	39 3/8"
Wt	31.8 lbs
Contact Sales for Pricing	

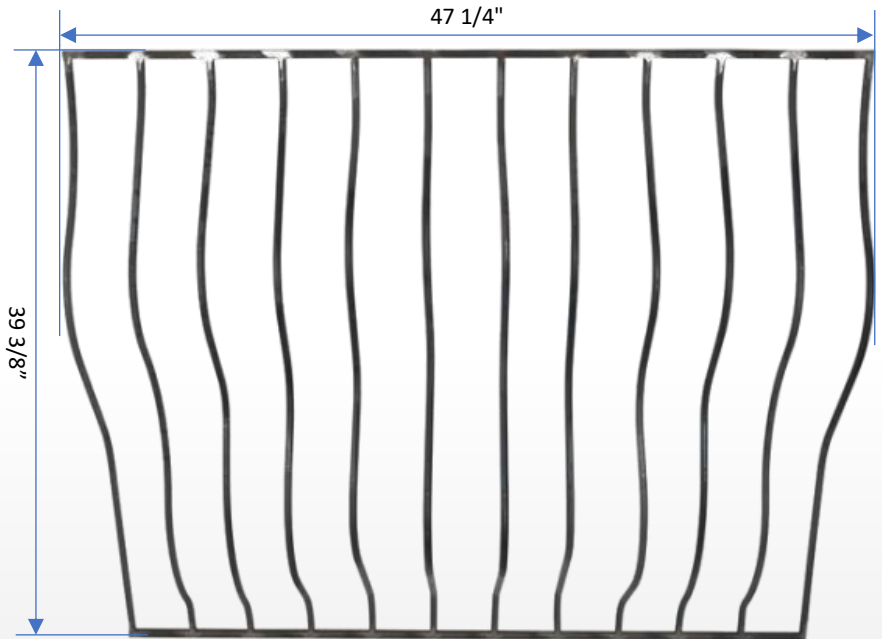

GD294/2



Accessories



Plain bar stock and special orders are available to complement your railing baluster patterns.

Product	Sq Straight Plain Bar	Sq Straight Plain Bar	Sq Straight Plain Bar	Sq Straight Plain Bar	Rec Straight Plain Bar
P/N	P/N 1368/4/39	P/N 1368/5/39	P/N 1368/4/44	P/N 1368/5/44	P/N 1368/13/1000
Mtl	12 mm ~ 1/2" □	14mm ~ 9/16" □	12 mm ~ 1/2" □	14mm ~ 9/16" □	5/16" x 9/16" ▢
W	1/2"	9/16"	1/2"	9/16"	9/16"
H	39 3/8"	39 3/8"	44"	44"	44"
Wt	1.9 lbs	3.4 lbs	2.8 lbs	3.8 lbs	3.8 lbs
MSRP	\$4.94	\$6.55	\$5.55	\$7.91	\$6.16

∅ Round Straight Plain Bars are available per special order.

Custom cut sizing may be special ordered for either square, round, or rectangular plain bars.



Available accessories:

- wrought iron & wooden hand rails and grab bars/wall rails
- handrail supports
- elegant scrolls & lambs tongue ends
- post caps
- flange covers & baluster shoes
- tubular scrolls
- custom sizing *and more!*

Primer and various Powder Coatings are also available as special orders. Customize your designs with a wide selection of colors and finishes.

This catalog only features a limited array of Gonzato Design products. To review the expanded product-line, request a printed version or download a catalog online at www.Indital.com > Catalogs > Gonzato Design Collection

As the world leader in wrought iron components, also review the various other Arteferro catalogs showcasing the full line of panels, railings, balusters, and accessories - <https://www.Indital.com/Catalogs>



MSRP pricing shown is subject to change based on market conditions. To verify pricing and product availability, contact Indital directly or an authorized distributor. General Sales Conditions, Warranty, and Liability provided with product order.



From Concept

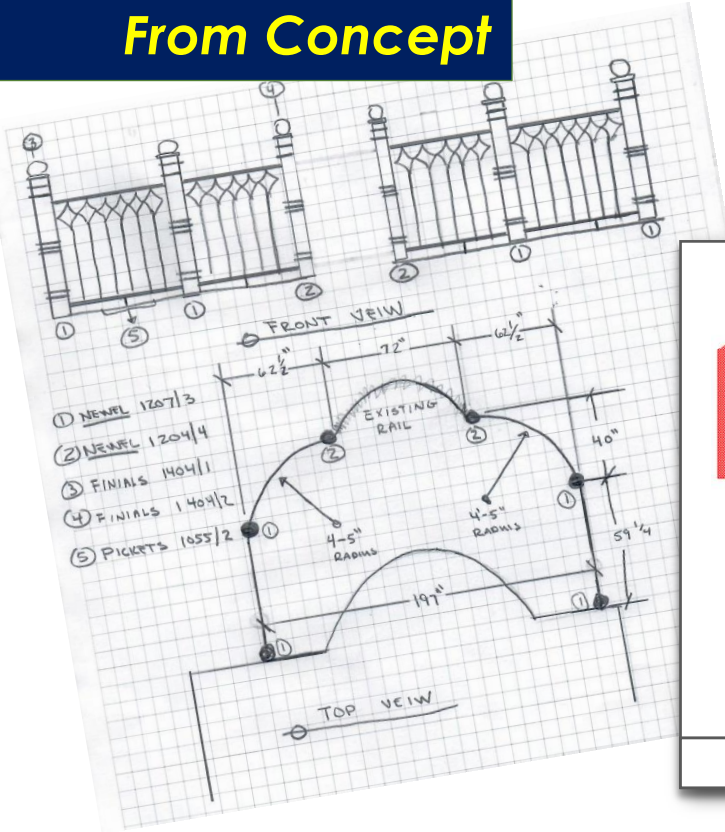

To CAD Layout

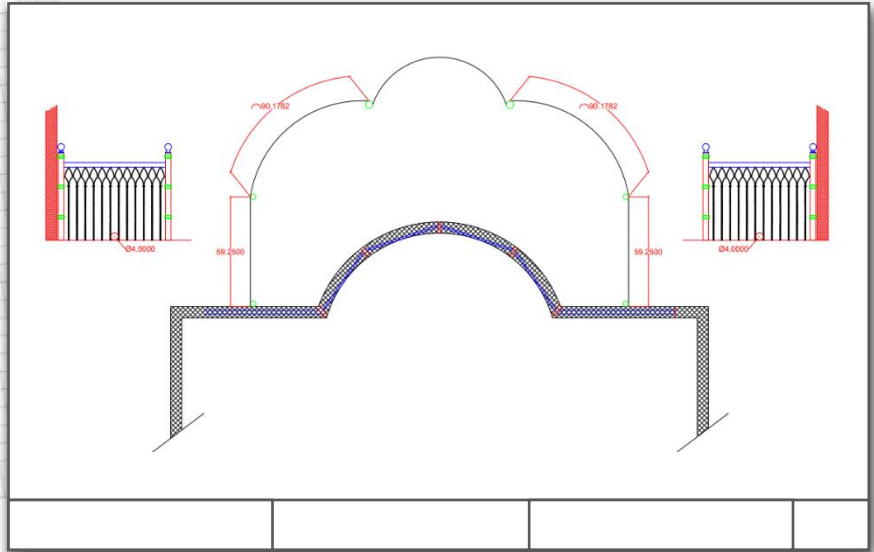

To 3D Visualization

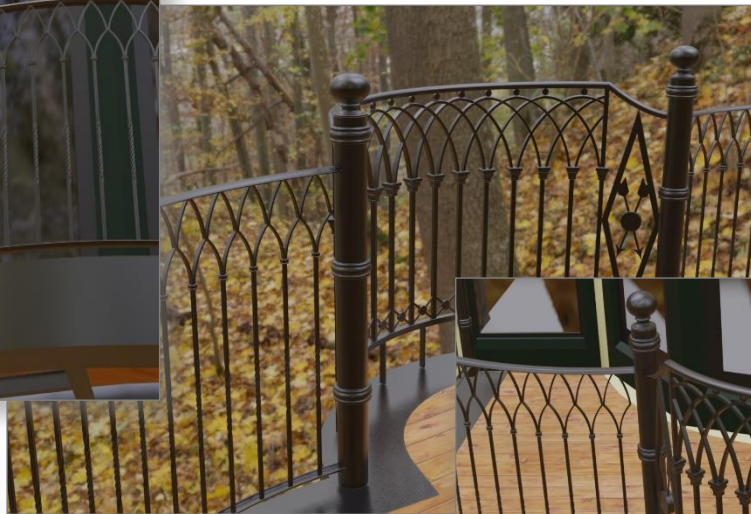

Our experienced drafting team can bring your vision to life, making product ordering easier and accurate. Indital is accustomed to working with architects, builders, homeowners and installers providing required product technical data, certifications, and varied file formats as needed.

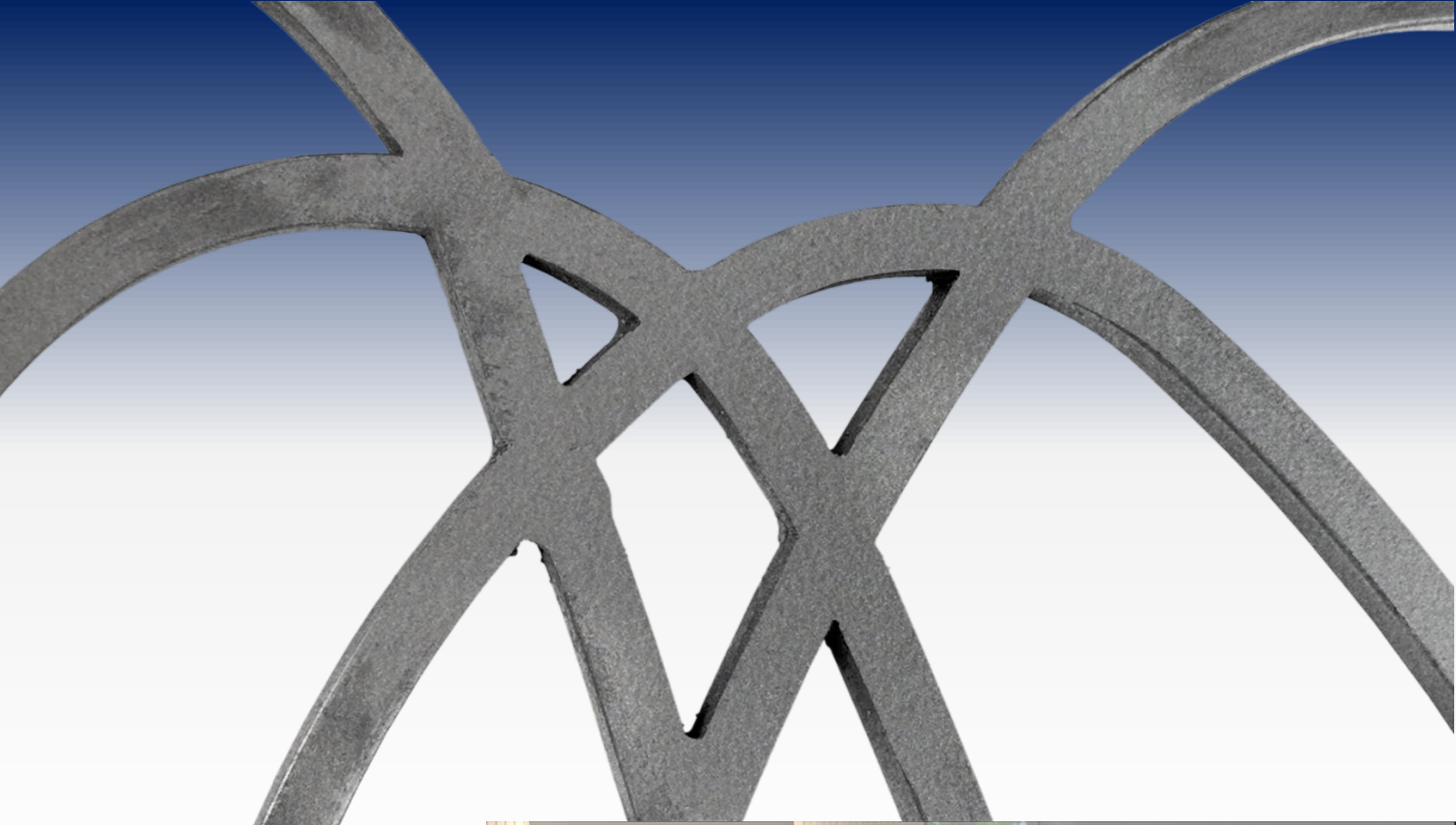

 **indital**[®]

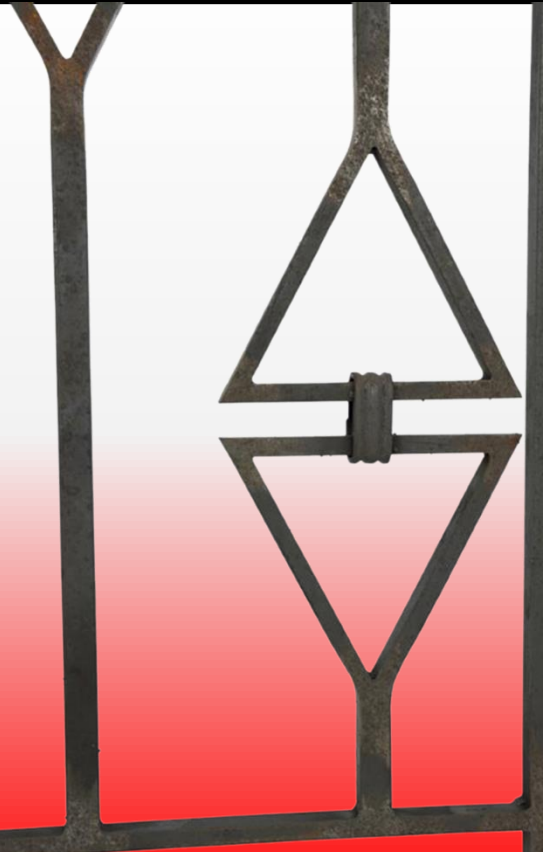

F0075 & F0076



by **arteferro**[®]

GONZATO DESIGNS is a SPECIAL COLLECTION of WROUGHT IRON STAIR PRODUCTS within the ARTEFERRO PRODUCT LINE.

Arteferro is a registered brand of Industria Italiana Arteferro S.p.A
Indital US Ltd • Phone: 800-772-4706 • Email: Forgings@Indital.com
www.Indital.com/Gonzato-Design